

CONTENT

1. EST (ELECTRICAL SAFETY TEST) RESULTS
2. QUALITY CONTROL CHECK LIST (BACK OF THE CABINET)
3. USER MANUAL
4. MULTIPLEXING
5. DIGITAL CONTROLLER MANUALS
6. PARAMETERS
7. ELECTRIC WIRE DIAGRAM (SOME USER MANUALS INCLUDES THIS)

Zu Position 1

Program: HORIZON Date: 31.03.2021 11:19

Tester:

Earth Test t= 1.0 s I= 10 AAC Umax= 12 V
AC

Testing by EN 60335
Rmin= 0 mOhm Rmax= 200 mOhm

Time	Resist.	Current	Error
Result			

11:18:28	84 mOhm	11.06 A	----
OK			

Insulation Test t= 1.0 s U= 1000 V Ustart= 10
0 V Rmin= 5.00 MOhm tRamp= 1.0 s

Time	Resist.	Voltage	Error
Result			

11:18:31	610 MOhm	1000 V	----
OK			

Flash Test t= 1.0 s U= 1000 VDC Ustart= 100 V
Imin= 0.00 mA Imax= 1.00 mA tRamp= 1.0 s

Time	Current	Voltage	Error
Result			

11:18:34	0.0 mA	1000 V	----
OK			

Load Test t= 90.0 s tg= 60.0 s Imin= 0.0 A I
max= 16.0 A

Time	Current	Analog	Error
Result			

11:19:35	3.6 A	0.0	----
OK			

Programresult=OK



HORIZON PLUG-IN

Installation and User Manual

CONTENT

- 1. Images.....2
 - 1.1 Installation Technical Drawing 2
 - 1.2 Transportation..... 3
 - 1.3 Product Serial ID Plate 3
 - 1.4 Installation and Environmental Factors 3
- 2. Images..... 4
 - 2.1 MULTIPLEXING 4
- 3. Images.....5
- 4. Refrigeration Diagram.....6
- 5. Electrical Wiring Diagram.....7
- 6. COSMETIC8 - 9
 - 6.1 Cosmetic Parts List 10
- 7. ENGINEERING..... **Hata! Yer işareti tanımlanmamış.**
 - 7.1 Engineering Parts List 12

1. Images

1.1 Installation Technical Drawing

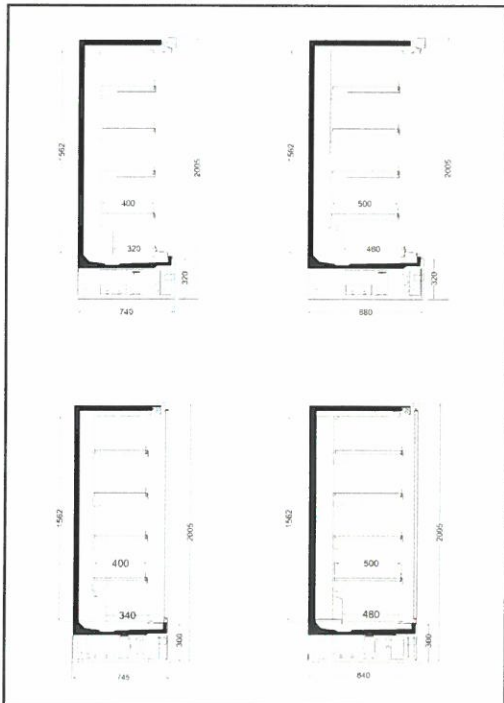

1.2 Transportation

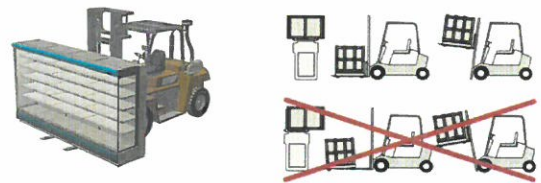

1.3 Product Serial ID Plate

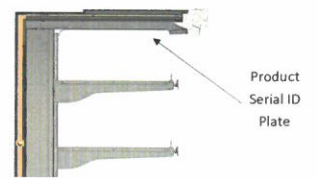

1.4 Installation and Environmental Factor

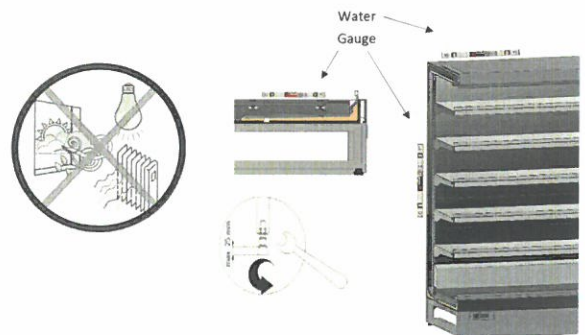

2. Images

2.1 MULTIPLEXING

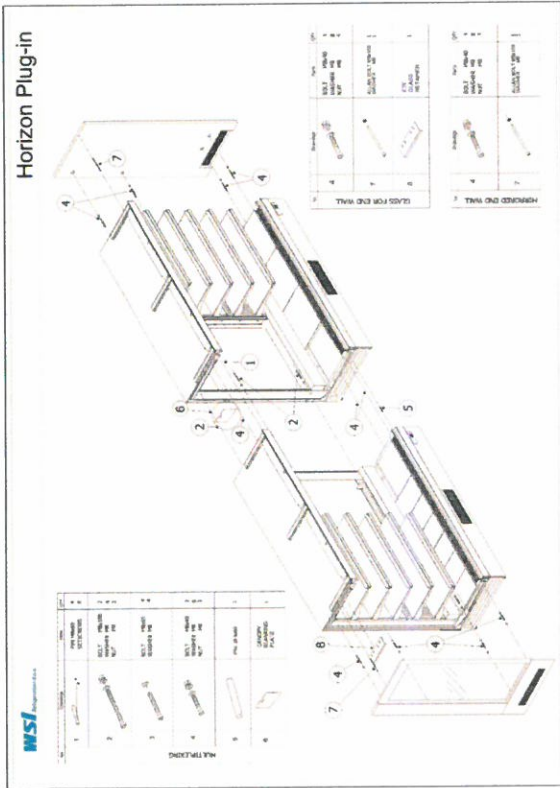

3. Image

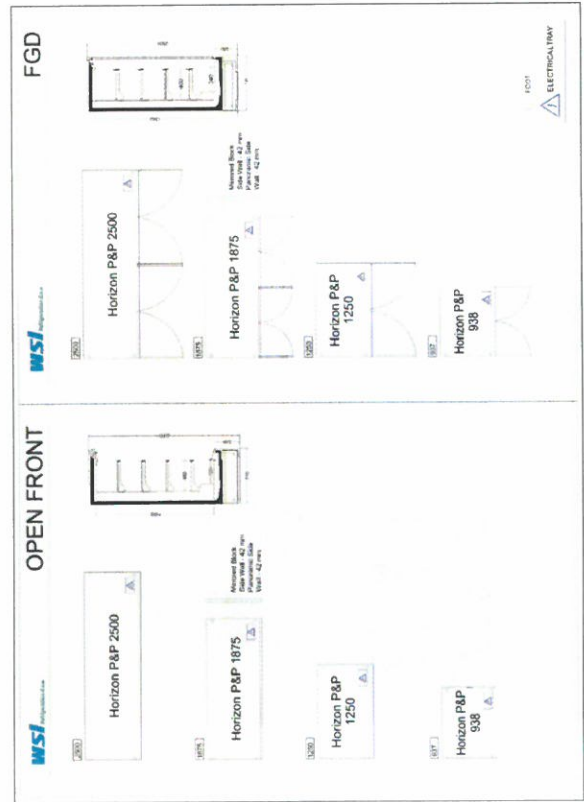

4. Refrigeration Diagram

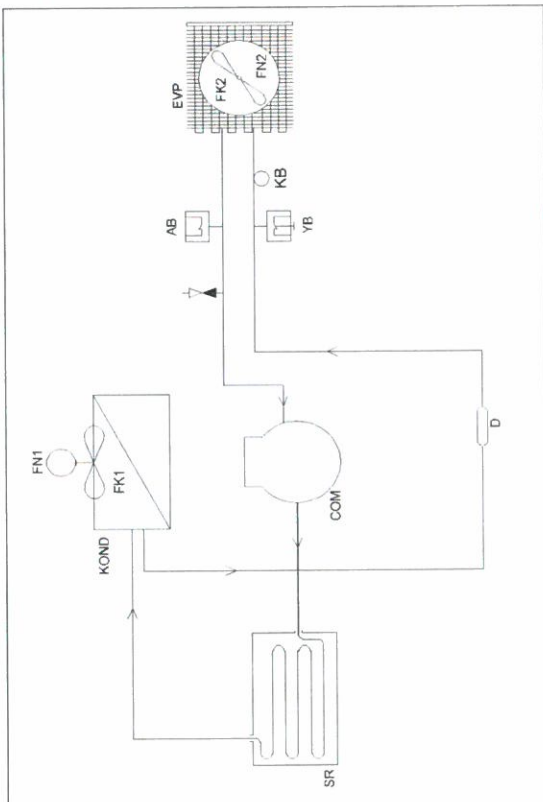

5. Electrical Wiring Diagram

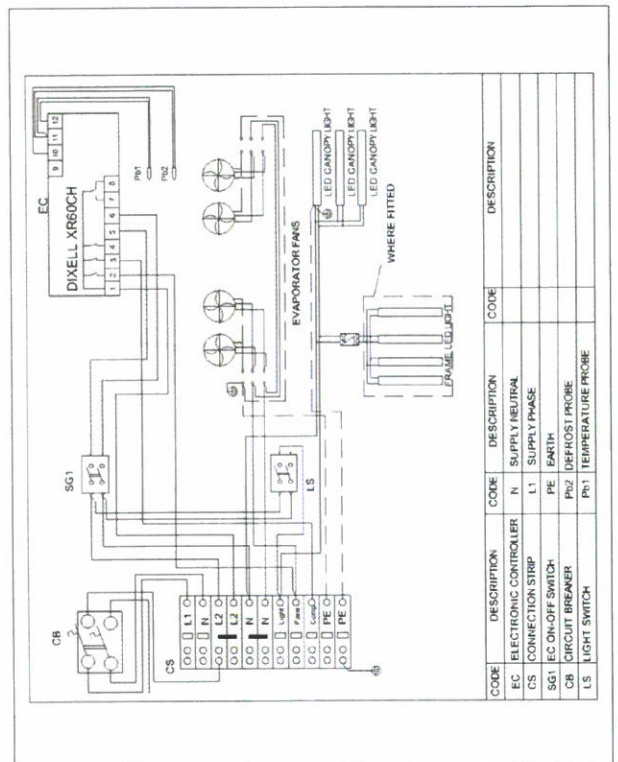

6. COSMETIC

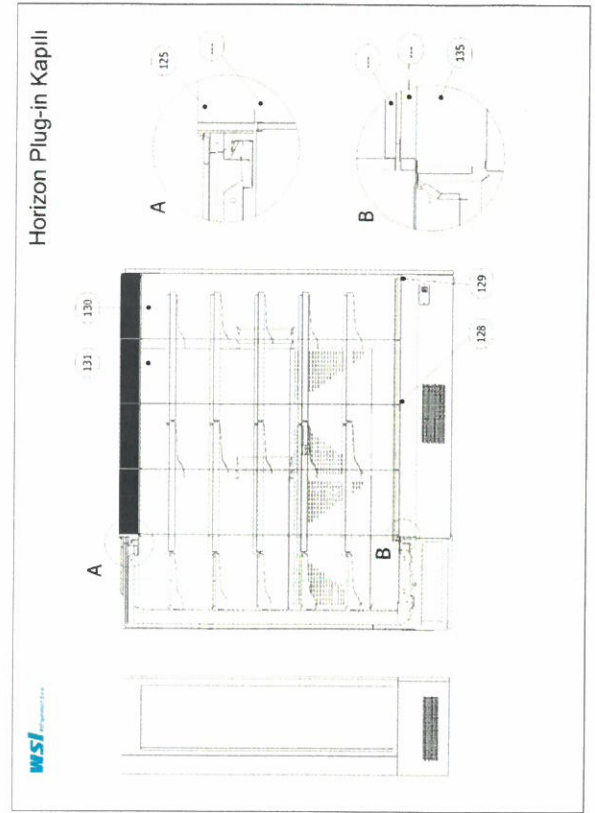
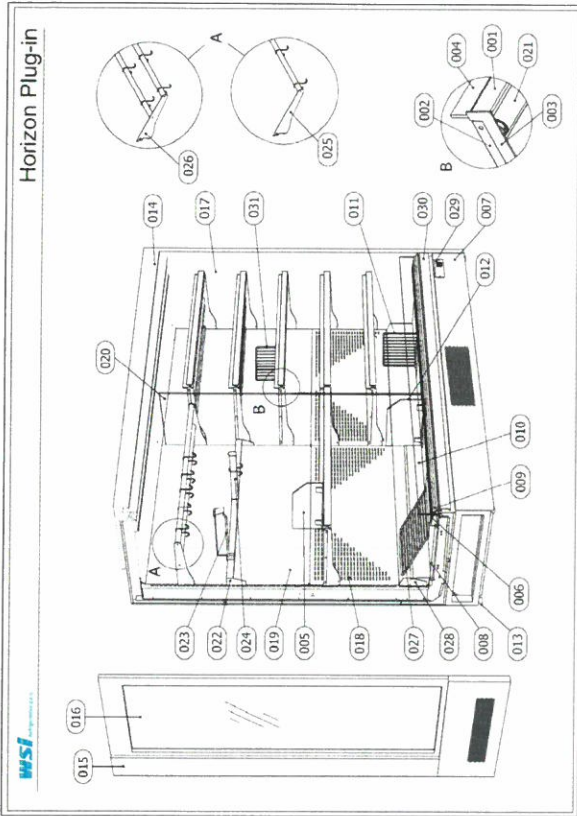

6.1 Cosmetic Parts List

PART NO	PART DESCRIPTION	938 PART NO:	1250 PART NO:	1875 PART NO:	2500 PART NO:
001	SHELF TICKET STRIP				
002	SHELF				
003	SHELF BRACKET				
004	SHELF PERSPEX RISER				
005	SHELF DIVIDER PERSPEX				
006	AIR RETURN GRILL				
007	MACHINERY GRILL				
008	BASE PLATE				
009	BASE TICKET STRIP				
010	BASE PERSPEX RISER				
011	BASE WIRE DIVIDER				
012	BASE PERSPEX DIVIDER				
013	FEET				
014	CANOPY				
015	DUAL GLAZED END WALL GABLE SET				
016	DUAL GLAZED GLASS				
017	BLOCK END WALL GABLE SET				
018	BACK PANEL - BOTTOM				
019	BACK PANEL - TOP				
020	PERSPEX SYSTEM DIVIDER				
021	SHELF LED				
022	PIN BAR				
023	HOOK WITH TICKET STRIP				
024	PROFILE HOOK				
025	SINGLE ROW HANGING PROFILE				
026	DOUBLE ROW HANGING PROFILE				
027	BASE WIRE				
028	WIRE GRILL ELEVATION BAR				
029	ISOLATOR COVER				
030	FRONT OVERLAY				
031	SHELF WIRE DIVIDER				
125	CANOPY PROFILE FOR DOOR				
126	CANOPY PROFILE FOR INSULATION PLASTIC				
127	BODY ALUMINIUM FOR DOOR				
128	RHS HINGE HOUSING HOLE				
129	LHS HINGE HOUSING HOLE				
130	RHS DOOR				
131	LHS DOOR				
132	DOOR PLASTIC				
133	KAPI SEAL				
134	ALUMINIUM				
135	FRONT OVERLAY				

7. ENGINEERING

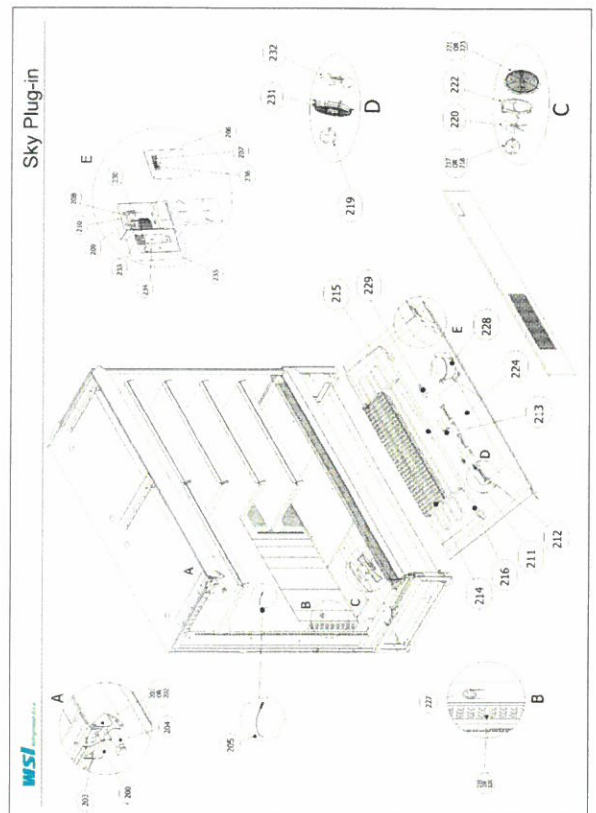

7.1 Engineering Parts List

PART NO	PART DESCRIPTION	938 PART NO:	1250 PART NO:	1875 PART NO:	2500 PART NO:
200	HONEYCOMB				
201	MANUAL NIGHT BLIND				
202	ELECTRONIC NIGHT BLIND				
203	NIGHT BLIND MOTOR				
204	T8 LED				
205	HEAT PROBE				
206	ON / OFF SWITCH				
207	LIGHT ON / OFF SWITCH				
208	FUSE				
209	CONTACTOR				
210	ELECTRICAL BOX				
211	HIGH PRESSURE SWITCH				
212	LOW PRESSURE SWITCH				
213	JUNCTION BOX				
214	INDUSTRIAL CLOTH				
215	CATHOD				
216	CONDENSATE TRAY				
217	EVAPORATOR FAN MOTOR				
218	EVAPORATOR Q FAN MOTOR EC				
219	CONDENSER FAN MOTOR EC				
220	METAL FAN BLADE 200mm DIA 32°				
221	FAN GAURD METAL				
222	FAN MOUNTING RING				
223	FAN GAURD PLASTIC				
224	CONDENSER (Micro Channel)				
225	EVAPORATOR – OPEN FRONT				
226	EVAPORATOR - FGD				
227	CAPILLARY				
228	COMPRESSOR				
229	DRIER				
230	TIME DELAY RELAY				
231	FAN GAURD				
232	CONDENSER FAN BLADE 200mm DIA 32°				
233	START RELAY				
234	RUN CAPACITOR				
235	START CAPACITOR				
236	DIGITAL CONTROLLER				

1.1 MULTIPLEXING

Horizon Plug-in



No	Drawings	Parts	QTY
1		PIN MB60 SETSCREWS	4 8
2		BOLT MR-100 WASHER MB NUT MB	4 4 2
3		BOLT MR60 WASHER MB	4 4
4		BOLT MR-40 WASHER MB NUT MB	3 6 3
5		PIN Ø 6x83	1
6		CANOPY BLANKING PLATE	1

MULTIPLEXING

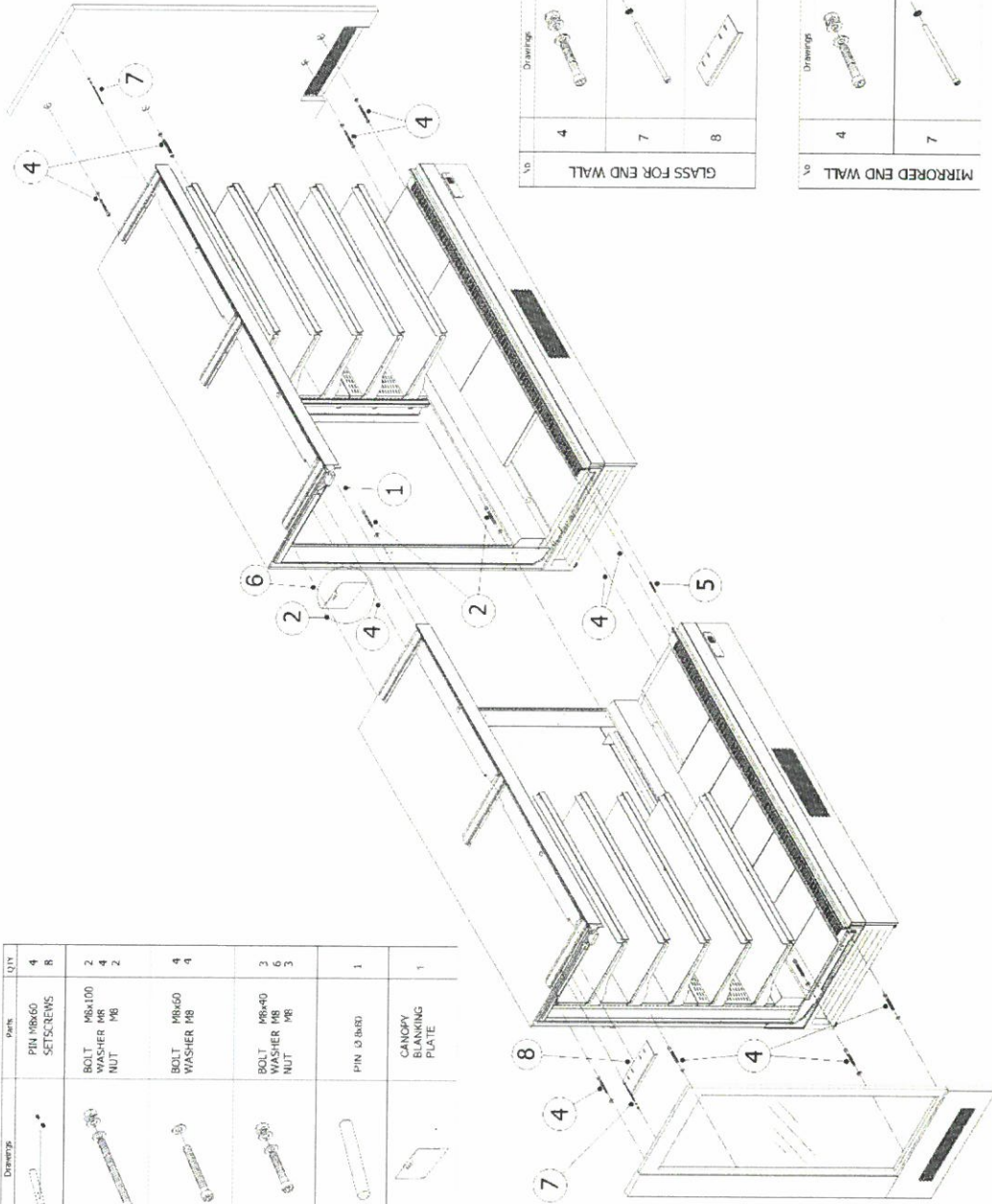

No	Drawings	Parts	QTY
4		BOLT MR-40 WASHER MB NUT MB	4 8 4
7		ALL-IN-BOLT MR-100 WASHER MB	1 1
8		E.W. GLASS RETAINER	1

No	Drawings	Parts	QTY
4		BOLT MR-40 WASHER MB NUT MB	4 8 4
7		ALL-IN-BOLT MR-100 WASHER MB	1 1

GLASS FOR END WALL

MIRRORED END WALL

Digital controller with defrost and fan management

XR70CH

CONTENTS

1. GENERAL WARNING 1
 2. GENERAL DESCRIPTION 1
 3. CONTROLLING LOADS 1
 4. FRONT PANEL COMMANDS 1
 5. MAX & MIN TEMPERATURE MEMORIZATION 1
 6. MAIN FUNCTIONS 2
 7. PARAMETERS 2
 8. DIGITAL INPUTS 3
 9. TTL SERIAL LINE – FOR MONITORING SYSTEMS 3
 10. X-REP OUTPUT – OPTIONAL 3
 11. INSTALLATION AND MOUNTING 4
 12. ELECTRICAL CONNECTIONS 4
 13. USE THE HOT KEY 4
 14. ALARM SIGNALS 4
 15. TECHNICAL DATA 4
 16. CONNECTIONS 4
 17. DEFAULT SETTING VALUES 5

1. GENERAL WARNING

1.1 PLEASE READ BEFORE USING THIS MANUAL

- This manual is part of the product and should be kept near the instrument for easy and quick reference.
- The instrument shall not be used for purposes different from those described hereunder. It cannot be used as a safety device.
- Check the application limits before proceeding.
- Dixell Srl reserves the right to change the composition of its products, even without notice, ensuring the same and unchanged functionality.

1.2 SAFETY PRECAUTIONS

- Check the supply voltage is correct before connecting the instrument.
- Do not expose to water or moisture: use the controller only within the operating limits avoiding sudden temperature changes with high atmospheric humidity to prevent formation of condensation
- Warning: disconnect all electrical connections before any kind of maintenance.
- Fit the probe where it is not accessible by the End User. The instrument must not be opened.
- In case of failure or faulty operation send the instrument back to the distributor or to "Dixell S.r.l." (see address) with a detailed description of the fault.
- Consider the maximum current which can be applied to each relay (see Technical Data).
- Ensure that the wires for probes, loads and the power supply are separated and far enough from each other, without crossing or intertwining.
- In case of applications in industrial environments, the use of mains filters (our mod. FT1) in parallel with inductive loads could be useful.
- Dixell Srl reserves the right to change the composition of its products, even without notice, ensuring the same and unchanged functionality.

2. GENERAL DESCRIPTION

Model XR70CH, format 32x74mm, is microprocessor based controller, suitable for applications on medium or low temperature ventilated refrigerating units. It has four relay outputs to control compressor, fan, and defrost, which can be either electrical or reverse cycle (hot gas). The last one can be used as light, for alarm signalling or as auxiliary output. It is also provided with up to 4 NTC or PTC probe inputs, the first one for temperature control, the second one, to be located onto the evaporator, to control the defrost termination temperature and to managed the fan. The digital input can operate as third temperature probe. The fourth one, to connect to the HOT KEY terminals, is used to signal the condenser temperature alarm or to display another temperature. The HOT-KEY output allows to connect the unit, by means of the external module XJ485-CX, to a network line ModBUS-RTU compatible such as the dixell monitoring units of X-WEB family. It allows to program the controller by means the HOT-KEY programming keyboard. The instrument is fully configurable through special parameters that can be easily programmed through the keyboard.

3. CONTROLLING LOADS

3.1 COMPRESSOR

The regulation is performed according to the temperature measured by the thermostat probe with a positive differential from the set point: if the temperature increases and reaches set point plus differential the compressor is started and then turned off when the temperature reaches the set point value again.

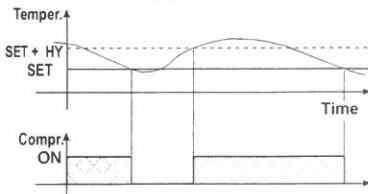

In case of fault in the thermostat probe the start and stop of the compressor are timed through parameters Con and CoF.

3.2 DEFROST

Two defrost modes are available through the tdF parameter: defrost through electrical heater (tdF=EL) and hot gas defrost (tdF=in). Other parameters are used to control the interval between defrost cycles (idF), its maximum length (MdF) and two defrost modes: timed or controlled by the evaporator's probe (P2P). At the end of defrost dripping time is started, its length is set in the Fdt parameter. With Fdt=0 the dripping time is disabled.

3.3 CONTROL OF EVAPORATOR FANS

The fan control mode is selected by means of the FnC parameter:
 FnC=C_n, fans will switch ON and OFF with the compressor and not run during defrost.
 FnC=o_n, fans will run even if the compressor is off, and not run during defrost.

After defrost, there is a timed fan delay allowing for drip time, set by means of the Fnd parameter.
 FnC=C_Y, fans will switch ON and OFF with the compressor and run during defrost.
 FnC=o_Y, fans will run continuously also during defrost.

An additional parameter FSt provides the setting of temperature, detected by the evaporator probe, above which the fans are always OFF. This is used to make sure circulation of air only if his temperature is lower than set in FSt.

3.3.1 Forced activation of fans

This function managed by the FCt parameter is designed to avoid short cycles of fans, that could happen when the controller is switched on or after a defrost, when the room air warms the evaporator. How it works: if the temperature difference between evaporator probe and room probe is higher than the FCt parameter value, fans will be switched on. With FCt=0 the function is disabled.

3.3.2 Cyclical activation of the fans with compressor off.

When FnC=C-n or C-Y (fans working in parallel with the compressor), by means of the Fon and FoF parameters the fans can carry out on and off cycles even if the compressor is switched off. When the compressor is stopped the fans go on working for the Fon time. With Fon=0 the fans remain always off, also when the compressor is off.

4. FRONT PANEL COMMANDS



SET	To display target set point; in programming mode it selects a parameter or confirm an operation.
	(DEF) To start a manual defrost.
	(UP) To see the max stored temperature; in programming mode it browses the parameter codes or increases the displayed value.
	(DOWN) To see the min stored temperature; in programming mode it browses the parameter codes or decreases the displayed value.
	To switch the instrument on and off (when onF=oFF).
	To switch on and off the light (when oA3=LiG).

KEY COMBINATIONS:

+	To lock & unlock the keyboard.
SET +	To enter in programming mode.
SET +	To return to the room temperature display.

4.1 USE OF LEDS

Each LED function is described in the following table.

LED	MODE	FUNCTION
	ON	Compressor enabled
	Flashing	Anti-short cycle delay enabled
	ON	Defrost enabled
	Flashing	Drip time in progress
	ON	Fans enabled
	Flashing	Fans delay after defrost in progress.
	ON	An alarm is occurring
	ON	Continuous cycle is running
	ON	Energy saving enabled
	ON	Light on
	ON	Auxiliary relay on
	ON	Measurement unit
	Flashing	Programming phase

5. MAX & MIN TEMPERATURE MEMORIZATION

5.1 HOW TO: SEE THE MIN TEMPERATURE

1. Press and release the DOWN key.
2. The "Lo" message will be displayed followed by the minimum temperature recorded.
3. By pressing the DOWN key again or by waiting 5 sec the normal display will be restored.

5.2 HOW TO: SEE THE MAX TEMPERATURE

1. Press and release the UP key.
2. The "Hi" message will be displayed followed by the maximum temperature recorded.
3. By pressing the UP key again or by waiting 5 sec the normal display will be restored.

5.3 HOW TO: RESET THE MAX AND MIN TEMPERATURE RECORDED

1. Keep the SET key pressed more than 3 sec, while the max or min temperature is displayed. ("rSt" message will be displayed)
2. To confirm the operation the "rSt" message will start blinking and the normal temperature will be displayed.

6. MAIN FUNCTIONS

6.1 HOW TO: SEE THE SET POINT

- 
1. Push and immediately release the SET key: the display will show the Set point value.
 2. Push and immediately release the SET key or wait for 5 sec to display the probe value again.

6.2 HOW TO CHANGE THE SET POINT

1. Push the SET key more than 2 sec to change the Set point value.
2. The value of the set point will be displayed and the °C or °F LED will start blinking.
3. To change the Set value push the UP or DOWN arrows within 10 sec.
4. To save the new set point value, push the SET key again or wait for 10 sec.

6.3 HOW TO START A MANUAL DEFROST

- 
- Push the DEF key for more than 2 sec and a manual defrost will start.

6.4 HOW TO: CHANGE A PARAMETER VALUE

- To change a parameter value, operate as follows:
1. Enter the Programming mode by pressing the SET+DOWN buttons for 3s (the °C or °F LED will start blinking).
 2. Select the required parameter. Press the SET button to display its actual value.
 3. Use UP or DOWN buttons to change its value.
 4. Press SET button to store the new value and move to the following parameter.

To exit: Press SET + UP buttons or waiting for 15s without pressing any key.

NOTE: the set value is stored even when the procedure is exited by waiting for the time-out to expire.

6.5 THE HIDDEN MENU

The hidden menu includes all the parameters of the instrument.

6.5.1 HOW TO: ENTER THE HIDDEN MENU

1. Enter the Programming mode by pressing the SET+DOWN buttons for 3 sec (the °C or °F LED will start blinking).
2. Released the buttons and then push again the SET+DOWN buttons for more than 7s. The Pr2 label will be displayed immediately followed from the HY parameter.
Now it is possible to browse the hidden menu.
3. Select the required parameter.
4. Press the SET button to display its value.
5. Use UP or DOWN to change its value.
6. Press SET to store the new value and move to the following parameter.

To exit: Press SET+DOWN or wait 15 sec without pressing a key.

NOTE1: if no parameter is present in Pr1 menu, after 3 sec the "noP" message will be displayed. Keep the buttons pushed till the Pr2 message will be displayed.

NOTE2: the set value is stored even when the procedure is exited by waiting for the time-out to expire.

6.5.2 HOW TO: MOVE A PARAMETER FROM THE HIDDEN MENU TO THE FIRST LEVEL AND VICEVERSA.

Each parameter present in the hidden menu (Pr2) can be moved into the user level (Pr1) by pressing SET+DOWN buttons. If a parameter is part of the user level, when showed in the hidden menu the decimal point will be lit.

6.6 HOW TO: LOCK THE KEYBOARD

1. Keep both UP and DOWN buttons pressed for more than 3 sec.
2. The "PoF" message will be displayed and the keyboard will be locked. At this point it will be possible only to see the set point or the MAX or Min temperature stored
3. If a button is pressed more than 3 sec the "PoF" message will be displayed

6.7 HOW TO: UNLOCK THE KEYBOARD

Keep pressed together for more than 3 sec the UP and DOWN keys till the "Pon" message will be displayed.

6.8 THE CONTINUOUS CYCLE

When defrost is not in progress, it can be activated by holding the UP key pressed for about 3 sec. The compressor operates to maintain the CCS set point for the time set through the CcT parameter. The cycle can be terminated before the end of the set time using the same activation key UP for 3 sec.

6.9 THE ON/OFF FUNCTION

- 
- With "onF = oFF", pushing the ON/OFF key, the instrument is switched off. The "OFF" message is displayed. In this configuration, the regulation is disabled. To switch the instrument on, push again the ON/OFF key.

WARNING: Loads connected to the normally closed contacts of the relays are always supplied and under voltage, even if the instrument is in stand by mode.

7. PARAMETERS

REGULATION

HY	Differential: (0.1 to 25.5°C; 1 to 45°F) intervention differential for set point. Compressor Cut IN is Set Point + differential (HY). Compressor Cut OUT is when the temperature reaches the set point.
LS	Minimum set point: (-100°C to SET; -148°F to SET) sets the minimum value for the set point.
US	Maximum set point: (SET to 150°C; SET to 302°F) set the maximum value for set point.
ot	Thermostat probe calibration: (-12.0 to 12.0°C; -21 to 21°F) allows to adjust possible offset of the thermostat probe.
P2P	Evaporator probe presence: (n; Y) n = not present, the defrost stops by time; Y = present, the defrost stops by temperature.
oE	Evaporator probe calibration: (-12.0 to 12.0°C; -21 to 21°F) allows to adjust possible offset of the evaporator probe.
P3P	Third probe presence (P3): (n; Y) n = not present, the terminals 18-20 operate as digital input; Y = present, the terminals 18-20 operate as third probe.
o3	Third probe calibration (P3): (-12.0 to 12.0°C; -21 to 21°F) allows to adjust possible offset of the third probe.
P4P	Fourth probe presence: (n; Y) n = Not present; Y = present.
o4	Fourth probe calibration: (-12.0 to 12.0°C; -21 to 21°F) allows to adjust possible offset of the fourth probe.
odS	Outputs activation delay at start up: (0 to 255min) this function is enabled at the initial start up of the instrument and inhibits any output activation for the period of time set in the parameter.
AC	Anti-short cycle delay: (0 to 50min) minimum interval between the compressor stop and the following restart.
rtr	Percentage of the second and first probe for regulation: (0 to 100; 100=P1, 0=P2) it allows to set the regulation according to the percentage of the first and second probe, as for the following formula (rtr(P1-P2)/100 + P2).
CcT	Compressor ON time during continuous cycle: (0.0 to 24h00min, res. 10min) allows to set the length of the continuous cycle. Compressor stays on without interruption during CcT time. This is useful, for instance, when the room is filled with new products.
CCS	Set point for continuous cycle: (-55 to 150°C; -67 to 302°F) it sets the set point used during the continuous cycle.
Con	Compressor ON time with faulty probe: (0 to 255min) time during which the compressor is active in case of faulty thermostat probe. With Con=0 compressor is always OFF.
CoF	Compressor OFF time with faulty probe: (0 to 255min) time during which the compressor is OFF in case of faulty thermostat probe. With CoF=0 compressor is always active.

DISPLAY

CF	Temperature measurement unit: (°C; °F) °C = Celsius; °F = Fahrenheit. WARNING: When the measurement unit is changed the SET point and the values of the parameters HY, LS, US, ot, ALU and ALL have to be checked and modified (if necessary).
rES	Resolution (for °C): ((n=1°C; dE=0.1°C) allows decimal point display.
Lod	Instrument display: (P1; P2, P3, P4, SET, dtr) it selects which probe is displayed by the instrument. P1 = Thermostat probe; P2 = Evaporator probe; P3 = Third probe (only for model with this option enabled); P4 = Fourth probe, SET = set point; dtr = percentage of visualization.
rEd	X-REP display (optional): (P1; P2, P3, P4, SET, dtr) it selects which probe is displayed by X- REP. P1 = Thermostat probe; P2 = Evaporator probe; P3 = Third probe (only for model with this option enabled); P4 = Fourth probe, SET = set point; dtr = percentage of visualization.
dLY	Display delay: (0 to 20min00s; res. 10s) when the temperature increases, the display is updated of 1°C or 1°F after this time.
dtr	Percentage of the second and first probe for visualization when Lod=dtr: (0 to 99; 100=P1, 0=P2) if Lod=dtr it allows to set the visualization according to the percentage of the first and second probe, as for the following formula (dtr(P1-P2)/100 + P2).

DEFROST

tdF	Defrost type: (EL; in) EL = electrical heater; in = hot gas.
dFP	Probe selection for defrost termination: (nP; P1; P2; P3; P4) nP = no probe; P1 = thermostat probe; P2 = evaporator probe; P3 = configurable probe; P4 = Probe on Hot Key plug.
dtE	Defrost termination temperature: (-55 to 50°C; -67 to 122°F) (enabled only when EdF=Pb) sets the temperature measured by the evaporator probe, which causes the end of defrost.
idF	Interval between defrost cycles: (0 to 120hours) determines the interval of time between two defrost cycles.
MdF	(Maximum) length for defrost: (0 to 255min) when P2P=n, (not evaporator probe: timed defrost) it sets the defrost duration. When P2P=Y (defrost end based on temperature) it sets the maximum length for defrost.
dSd	Start defrost delay: (0 to 99min) this is useful when different defrost start times are necessary to avoid overloading the plant.
dFd	Temperature displayed during defrost: (rt; it; SET; dEF) rt = real temperature; it = temperature at defrost start; SET = set point; dEF = "dEF" label.
dAd	MAX display delay after defrost: (0 to 255min) sets the maximum time between the end of defrost and the restarting of the real room temperature display.
Fdt	Drip time: (0 to 120min) time interval between reaching defrost termination temperature and the restoring of the control's normal operation. This time allows the evaporator to eliminate water drops that might have formed due to defrost.
dPo	First defrost after start-up: (n; Y) <ul style="list-style-type: none"> • n = after the idF time, • Y = immediately.
dAF	Defrost delay after continuous cycle: (0.0 to 24h00min, res. 10min) time interval between the end of the fast freezing cycle and the following defrost related to it.

FANS	
FnC	Fans operating mode: (C-n; o-n; C-Y; o-Y) C-n = runs with the compressor, OFF during defrost; o-n = continuous mode, OFF during defrost; C-Y = runs with the compressor, ON during defrost; o-Y = continuous mode, ON during defrost.
Fnd	Fans delay after defrost: (0 to 255min) interval between end of defrost and evaporator fans start.
FCT	Temperature differential to avoid fan short cycles: (0 to 59°C; 0 to 90°F) (N.B.: if FCT=0 function disabled) if the difference of temperature between the evaporator and the room probes is higher than FCT value, the fans will be switched on.
FSt	Fans stop temperature: (-55 to 50°C; -67 to 122°F) setting of temperature, detected by evaporator probe, above which fans are always OFF.
Fon	Fan ON time: (0 to 15min) with FnC=C_n or C_Y, (fan activated in parallel with compressor) it sets the evaporator fan ON cycling time when the compressor is off. With Fon=0 and FoF≠0 the fan are always off, with Fon=0 and FoF=0 the fan are always off.
FoF	Fan OFF time: (0 to 15min) With FnC=C_n or C_Y, (fan activated in parallel with compressor) it sets the evaporator fan off cycling time when the compressor is off. With Fon=0 and FoF≠0 the fan are always off, with Fon=0 and FoF=0 the fan are always off.
FAP	Probe selection for fan management: (nP; P1; P2; P3; P4) nP = no probe; P1 = thermostat probe; P2 = evaporator probe; P3 = configurable probe; P4 = Probe on Hot Key plug.

ALARMS	
ALC	Temperature alarms configuration: (Ab; rE) Ab = absolute temperature, alarm temperature is given by the ALL or ALU values. rE = temperature alarms are referred to the set point. Temperature alarm is enabled when the temperature exceeds the [SET+ALU] or [SET-ALL] values.
ALU	MAXIMUM temperature alarm: <ul style="list-style-type: none"> If ALC=Ab: [ALL to 150.0°C or ALL to 302°F] If ALC=rE: [0.0 to 50.0°C or 0 to 90°F] when this temperature is reached the alarm is enabled, after the ALd delay time.
ALL	Minimum temperature alarm: <ul style="list-style-type: none"> If ALC=Ab: [-100°C to ALU; -148 to ALU] If ALC=rE: [0.0 to 50.0°C or 0 to 90°F] when this temperature is reached the alarm is enabled, after the ALd delay time.
AFH	Differential for temperature alarm recovery: (0.1 to 25.5°C; 1 to 45°F) intervention differential for recovery of temperature alarm.
ALd	Temperature alarm delay: (0 to 255 min) time interval between the detection of an alarm condition and alarm signalling.
dAo	Exclusion of temperature alarm at start-up: (0.0 to 24h00min, res. 10min) time interval between the detection of the temperature alarm condition after instrument power on and alarm signalling.

CONDENSER TEMPERATURE ALARM	
AP2	Probe selection for temperature alarm of condenser: (nP; P1; P2; P3; P4) nP = no probe; P1 = thermostat probe; P2 = evaporator probe; P3 = configurable probe; P4 = Probe on Hot Key plug.
AL2	Low temperature alarm of condenser: (-100 to 150°C; -148 to 302°F) when this temperature is reached the LA2 alarm is signalled, possibly after the Ad2 delay.
Au2	High temperature alarm of condenser: (-100 to 150°C; -148 to 302°F) when this temperature is reached the HA2 alarm is signalled, possibly after the Ad2 delay.
AH2	Differential for temperature condenser alarm recovery: 0.1 to 25.5°C; 1 to 45°F
Ad2	Condenser temperature alarm delay: (0 to 255 min) time interval between the detection of the condenser alarm condition and alarm signalling.
dA2	Condenser temperature alarm exclusion at start up: 0.0 to 24h00min, res. 10min.
bLL	Compressor off with low temperature alarm of condenser: (n; Y) n = compressor keeps on working; Y = compressor is switched off till the alarm is present, in any case regulation restarts after AC time at minimum.
AC2	Compressor off with high temperature alarm of condenser: (n; Y) n = compressor keeps on working; Y = compressor is switched off till the alarm is present, in any case regulation restarts after AC time at minimum.

FOURTH RELAY	
tbA	Alarm relay silencing (with oA3=ALr): (n; Y) n = silencing disabled: alarm relay stays on till alarm condition lasts. Y = silencing enabled: alarm relay is switched OFF by pressing a key during an alarm.
oA3	Second relay configuration (1-4): (dEF; FAn; ALr; LiG; AUS; onF; db; dEF2; HES) dEF = defrost; FAn = do not select it; ALr = alarm; LiG = light; AUS = Auxiliary relay; onF = always on with instrument on; db = neutral zone; dEF2 = do not select it; HES = night blind.
AoP	Alarm relay polarity: (CL; oP) it set if the alarm relay is open or closed when an alarm occurs. CL = terminals 1-4 closed during an alarm; oP = terminals 1-4 open during an alarm.

DIGITAL INPUTS	
i1P	Second digital input polarity: (oP; CL) oP = the digital input is activated by opening the contact; CL = the digital input is activated by closing the contact.
i1F	Second digital input configuration: (EAL; bAL; PAL; dor; dEF; ES; AUS; Htr; FAn; HdF; onF) EAL = external alarm: "EA" message is displayed; bAL = serious alarm "CA" message is displayed; PAL = pressure switch alarm, "CA" message is displayed; dor = door switch function; dEF = activation of a defrost cycle; ES = energy saving; AUS = auxiliary relay activation with oA3=AUS; Htr = type of inverting action (cooling or heating); FAn = fan; HdF = Holiday defrost (enable only with RTC); onF = to switch the controller off.
did	Digital input 1 alarm delay: (0 to 255 min) delay between the detection of the external alarm condition and its signalling. When i1F= PAL, it is the interval of time to calculate the number of pressure switch activation.

nPS	Number of pressure switch activation: (0 to 15) Number of activation, during the did or d2d interval, before signalling an alarm event (i1F, i2F=PAL). If the nPS activation during did or d2d time is reached, switch off and on the instrument to restart normal regulation.
odC	Compressor status when open door: (no; FAn; CPr; F_C;) no = normal; FAn = normal; CPr = compressor OFF; F_C = compressor OFF.
rrd	Outputs restart after door open alarm: (n; Y) n = outputs follow the odC parameter. Y = outputs restart with a door open alarm.
HES	Delta temperature during an Energy Saving cycle: (-30.0 to 30.0°C; -54 to 54°F) it sets the increasing value of the set point [SET+HES] during the Energy Saving cycle.

OTHER	
Adr	Serial address: (1 to 247) identifies the instrument address when connected to a ModBUS compatible monitoring system.
PbC	Type of probe: (PtC; nTC) it allows to set the kind of probe used by the instrument: PtC = PTC probe, nTC = NTC probe.
onF	On/Off key enabling: (nU; oFF; ES) nU = disabled; oFF = enabled; ES = not set it.
dP1	Thermostat probe display.
dP2	Evaporator probe display.
dP3	Third probe display- optional.
dP4	Fourth probe display.
rSE	Real set point: it shows the set point used during the energy saving cycle or during the continuous cycle.
rEL	Software release for internal use.
Ptb	Parameter table code: readable only.

8. DIGITAL INPUTS

The free voltage digital input is programmable by the i1F parameter.

8.1 GENERIC ALARM (i1F = EAL)

As soon as the digital input is activated the unit will wait for did time delay before signalling the EAL alarm message. The outputs statuses don't change. The alarm stops just after the digital input is deactivated.

8.2 SERIOUS ALARM MODE (i1F = BAL)

When the digital input is activated, the unit will wait for did delay before signalling the CA alarm message. The relay outputs are switched OFF. The alarm will stop as soon as the digital input is deactivated.

8.3 PRESSURE SWITCH (i1F = PAL)

If during the interval time set by did parameter, the pressure switch has reached the number of activation of the nPS parameter, the CA pressure alarm message will be displayed. The compressor and the regulation are stopped. When the digital input is ON the compressor is always OFF. If the nPS activation in the did time is reached, switch off and on the instrument to restart normal regulation.

8.4 DOOR SWITCH INPUT (i1F = DOR)

It signals the door status and the corresponding relay output status through the odC parameter. no = normal (any change); FAn = Fan OFF; CPr = Compressor OFF; F_C = Compressor and fan OFF. Since the door is opened, after the delay time set through parameter doA, the door alarm is enabled, the display shows the message dA and the regulation restarts if rtr=YES. The alarm stops as soon as the external digital input is disabled again. With the door open, the high and low temperature alarms are disabled.

8.5 START DEFROST (i1F = DEF)

It starts a defrost if there are the right conditions. After the defrost is finished, the normal regulation will restart only if the digital input is disabled otherwise the instrument will wait until the "MdF" safety time is expired.

8.6 SWITCH THE AUXILIARY RELAY (i1F = AUS)

With oA3 = AUS the digital input switched the status of the auxiliary relay

8.7 INVERSION OF THE KIND OF ACTION: HEATING-COOLING (i1F=HTR)

This function allows to invert the regulation of the controller: from cooling to heating and viceversa.

8.8 ENERGY SAVING (i1F = ES)

The Energy Saving function allows to change the set point value as the result of the SET+ HES (parameter) sum. This function is enabled until the digital input is activated.

8.9 ON OFF FUNCTION (i1F = ONF)

To switch the controller on and off.

8.10 DIGITAL INPUT POLARITY

The digital input polarity depends on the i1P parameter. i1P = CL: the input is activated by closing the contact. i1P = oP: the input is activated by opening the contact

9. TTL SERIAL LINE – FOR MONITORING SYSTEMS

The TTL serial line, available through the HOT KEY connector, allows to connect the instrument to a monitoring system ModBUS-RTU compatible such as the XWEB500.

10. X-REP OUTPUT – OPTIONAL

As optional, an X-REP can be connected to the instrument, through the dedicated connector.



To connect the X-REP to the instrument the following connectors must be used CAB-51F(1m), CAB-52F(2m), CAB-55F(5m).

11. INSTALLATION AND MOUNTING

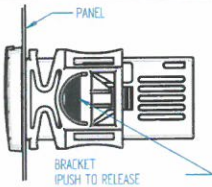

Instrument XR70CH shall be mounted on vertical panel, in a 29x71 mm hole, and fixed using the special bracket supplied. The temperature range allowed for correct operation is 0 to 60°C. Avoid places subject to strong vibrations, corrosive gases, excessive dirt or humidity. The same recommendations apply to probes. Let air circulate by the cooling holes.

12. ELECTRICAL CONNECTIONS

The instrument is provided with screw terminal block to connect cables with a cross section up to 2.5mm². Before connecting cables make sure the power supply complies with the instrument's requirements. Separate the probe cables from the power supply cables, from the outputs and the power connections. Do not exceed the maximum current allowed on each relay, in case of heavier loads use a suitable external relay.

12.1 PROBE CONNECTION

The probes shall be mounted with the bulb upwards to prevent damages due to casual liquid infiltration. It is recommended to place the thermostat probe away from air streams to correctly measure the average room temperature. Place the defrost termination probe among the evaporator fins in the coldest place, where most ice is formed, far from heaters or from the warmest place during defrost, to prevent premature defrost termination.

13. USE THE HOT KEY

13.1 HOW TO: PROGRAM A HOT KEY FROM THE INSTRUMENT (UPLOAD)

1. Program one controller with the front keypad.
2. When the controller is ON, insert the "HOT-KEY" and push UP button; the "uPL" message appears followed a by a flashing "End" label.
3. Push SET button and the "End" will stop flashing.
4. Turn OFF the instrument, remove the "HOT-KEY" and then turn it ON again.

NOTE: the "Err" message appears in case of a failed programming operation. In this case push again button if you want to restart the upload again or remove the "HOT-KEY" to abort the operation.

13.2 HOW TO: PROGRAM AN INSTRUMENT USING A HOT KEY (DOWNLOAD)

1. Turn OFF the instrument.
2. Insert a pre-programmed "HOT-KEY" into the 5-PIN receptacle and then turn the Controller ON.
3. The parameter list of the "HOT-KEY" will be automatically downloaded into the Controller memory. The "doL" message will blink followed a by a flashing "End" label.
4. After 10 seconds the instrument will restart working with the new parameters.
5. Remove the "HOT-KEY".

NOTE: the message "Err" is displayed for failed programming. In this case turn the unit off and then on if you want to restart the download again or remove the "HOT-KEY" to abort the operation.

14. ALARM SIGNALS

Message	Cause	Outputs
"P1"	Room probe failure	Compressor output acc. to par. Con and CoF
"P2"	Evaporator probe failure	Defrost end is timed
"P3"	Third probe failure	Outputs unchanged
"P4"	Fourth probe failure	Outputs unchanged
"HA"	Maximum temperature alarm	Outputs unchanged.
"LA"	Minimum temperature alarm	Outputs unchanged.
"HA2"	Condenser high temperature	It depends on the AC2 parameter
"LA2"	Condenser low temperature	It depends on the bLL parameter
"dA"	Door open	Compressor and fans restarts
"EA"	External alarm	Output unchanged.
"CA"	Serious external alarm (i2F=bAL)	All outputs OFF.
"CA"	Pressure switch alarm (i2F=PAL)	All outputs OFF
"rtc"	Real time clock alarm	Alarm output ON; Other outputs unchanged; Defrosts according to par. idF Set real time clock has to be set
rtF	Real time clock board failure	Alarm output ON; Other outputs unchanged; Defrosts according to par. idF Contact the service

14.1 ALARM RECOVERY

Probe alarms "P1", "P2", "P3" and "P4" start some seconds after the fault in the related probe; they automatically stop some seconds after the probe restarts normal operation. Check connections before replacing the probe. Temperature alarms "HA", "LA", "HA2" and "LA2" automatically stop as soon as the temperature returns to normal values. Alarms "EA" and "CA" (with i2F=bAL) recover as soon as the digital input is disabled. Alarm "CA" (with i2F=PAL) recovers only by switching off and on the instrument.

14.2 OTHER MESSAGES

Pon	Keyboard unlocked.
poF	Keyboard locked
noP	In programming mode: none parameter is present in Pr1 On the display or in dP2, dP3, dP4: the selected probe is nor enabled

15. TECHNICAL DATA

Housing: self extinguishing ABS.
 Case: frontal 38x80 mm; depth 62mm;
 Mounting: panel mounting in a 71x29mm panel cut-out
 Protection: IP20; Frontal protection: IP65
 Connections: Screw terminal block ≤ 2.5 mm² wiring
 Power supply: according to the model
 12VAC/DC, ±10%
 110AC ±10%, 50/60Hz
 230VAC ±10%, 50/60Hz
 Power absorption: 3VA max
 Display: 3 digits, red LED, 14.2 mm high
 Inputs: Up to 4 NTC or PTC probes
 Digital inputs: free voltage contact
 Relay outputs: compressor SPST 8(3) A, 250VAC or SPST 16A 250VAC
 Defrost: SPDT 8(3) A, 250VAC
 Fan: SPST 5A, 250VAC
 Aux: SPDT 8(3) A, 250VAC
 Buzzer: optional
 Data storing: on the non-volatile memory (EEPROM)
 Internal clock back-up: 24 hours
 Kind of action: 1B
 Pollution degree: 2
 Software class: A
 Rated impulsive voltage: 2500V
 Overvoltage Category: II
 Operating temperature: 0 to 55°C
 Storage temperature: -25 to 60°C
 Relative humidity: 20 to 85% (no condensing)
 Measuring and regulation range:
 NTC probe: -40 to 110°C (-40 to 230°F)
 PTC probe: -100 to 150°C (-148 to 302°F)
 Resolution: 0.1°C or 1°C or 1°F (selectable)
 Accuracy (ambient temp. 25°C): ±0.7°C ±1 digit

16. CONNECTIONS

The X-REP output excludes the TTL output. It's present in the following codes: XR70CH- xx2xx, XR70CH -xx3xx;

16.1 XR70CH – 8A OR 16A COMP. RELAY - 230VAC OR 110VAC

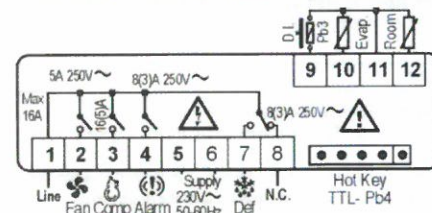

NOTE: The compressor relay is 8(3)A or 16(6)A according to the model.
 24Vac supply: connect to the terminals 5 and 6.

16.2 XR70CH – 4 X 16A - 12VAC/DC

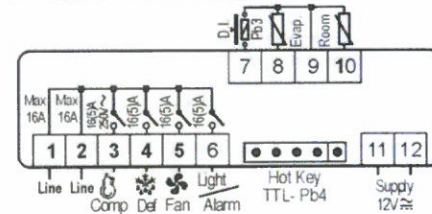

17. DEFAULT SETTING VALUES

Label	Name	Range	Value	Level
SEt	Set point	LS; US	-5.0	---
HY	Differential	[0.1 to 25.5°C] [1 to 45°F]	2.0	Pr1
LS	Minimum set point	[-100°C to SET] [-148°F to SET]	-50.0	Pr2
US	Maximum set point	[SET to 150°C] [SET to 302°F]	110	Pr2
ot	Thermostat probe calibration	[-12.0 to 12.0°C] [-21 to 21°F]	0.0	Pr1
P2P	Evaporator probe presence	n; Y	Y	Pr1
oE	Evaporator probe calibration	[-12.0 to 12.0°C] [-21 to 21°F]	0.0	Pr2
P3P	Third probe presence	n; Y	n	Pr2
o3	Third probe calibration	[-12.0 to 12.0°C] [-21 to 21°F]	0	Pr2
P4P	Fourth probe presence	n; Y	n	Pr2
o4	Fourth probe calibration	[-12.0 to 12.0°C] [-21 to 21°F]	0	Pr2
odS	Outputs delay at start up	0 to 255 min	0	Pr2
AC	Anti-short cycle delay	0 to 50 min	1	Pr1
rtr	P1-P2 percentage for regulation	0 to 100 (100=P1, 0=P2)	100	Pr2
CcT	Continuous cycle duration	0.0 to 24h00min, res. 10 min	0.0	Pr2
CCS	Set point for continuous cycle	[-100 to 150.0°C] [-148 to 302°F]	-5	Pr2
Con	Compressor ON time with faulty probe	0 to 255 min	15	Pr2
CoF	Compressor OFF time with faulty probe	0 to 255 min	30	Pr2
CF	Temperature measurement unit	°C; °F	°C	Pr2
rES	Resolution	dE; in	dE	Pr1
Lod	Probe displayed	P1; P2; P3; P4; SEt; dtr	P1	Pr2
rEd	X-REP display	P1; P2; P3; P4; SEt; dtr	P1	Pr2
dLY	Display temperature delay	0.0 to 20min00sec, res. 10 sec	0.0	Pr2
dtr	P1-P2 percentage for display	1 to 99	50	Pr2
tdF	Defrost type	EL; in	EL	Pr1
dFP	Probe selection for defrost termination	nP; P1; P2; P3; P4	P2	Pr2
dtE	Defrost termination temperature	[-55 to 50.0°C] [-67 to 122°F]	8	Pr1
idF	Interval between defrost cycles	0 to 120 hours	6	Pr1
MdF	(Maximum) length for defrost	0 to 255 min	30	Pr1
dSd	Start defrost delay	0 to 255 min	0	Pr2
dFd	Displaying during defrost	rt; it; SEt; dEF	it	Pr2
dAd	MAX display delay after defrost	0 to 255 min	30	Pr2
Fdt	Draining time	0 to 255 min	0	Pr2
dPo	First defrost after start-up	n; Y	n	Pr2
dAF	Defrost delay after fast freezing	0.0 to 24h00min, res. 10 min	0.0	Pr2
FnC	Fan operating mode	C-n; o-n; C-Y; o-Y	o-n	Pr1
Fnd	Fan delay after defrost	0 to 255 min	10	Pr1
FCt	Differential of temperature for forced activation of fans	[0 to 50°C] [0 to 90°F]	10	Pr2
FSt	Fan stop temperature	[-55 to 50.0°C] [-67 to 122°F]	2	Pr1
Fon	Fan on time with compressor off	0 to 15 min	0	Pr2
FoF	Fan off time with compressor off	0 to 15 min	0	Pr2
FAP	Probe selection for fan management	nP; P1; P2; P3; P4	P2	Pr2
ALC	Temperat. alarms configuration	rE; Ab	Ab	Pr2
ALU	MAXIMUM temperature alarm	Rel: [0.0 to 50.0°C] [0 to 90°F] AbS: [ALL to 150°C] [ALL to 302°F]	110.0	Pr1
ALL	Minimum temperature alarm	Rel: [0.0 to 50.0°C] [0 to 90°F] AbS: [-100°C to ALU] [-148°F to ALU]	-50.0	Pr1
AFH	Differential for temperat. alarm recovery	[0.1 to 25.5°C] [1 to 45°F]	1.0	Pr2
ALd	Temperature alarm delay	0 to 255 min	15	Pr2
dAo	Delay of temperature alarm at start up	0.0 to 24h00min, res. 10 min	1.3	Pr2
AP2	Probe for temperat. alarm of condenser	nP; P1; P2; P3; P4	P4	Pr2
AL2	Condenser for low temperat. alarm	[-100 to 150°C] [-148 to 302°F]	-40	Pr2
AU2	Condenser for high temperat. alarm	[-100 to 150°C] [-148 to 302°F]	110	Pr2
AH2	Differ. for condenser temp. alar. recovery	[0.1 to 25.5°C] [1 to 45°F]	5	Pr2
Ad2	Condenser temperature alarm delay	0 to 254 min, 255(nu)	15	Pr2
dA2	Delay of cond. temper. alarm at start up	0.0 to 24h00min, res. 10 min	1.3	Pr2
bLL	Compr. off for condenser low temperature alarm	n; Y	n	Pr2
AC2	Compr. off for condenser high temperature alarm	n; Y	n	Pr2
tbA	Alarm relay disabling	n; Y	Y	Pr2
oA3	Fourth relay configuration	ALr = alarm; dEF = do not select it; LiG =Light; AUS =AUX; onF=always on; FAn= do not select it; db = neutral zone; CP2 = second compressor; dF2 = do not select it	ALr	Pr2
AOp	Alarm relay polarity (oA3=ALr)	oP; CL	CL	Pr2
i1P	Digital input polarity (18-19)	oP; CL	CL	Pr1
i1F	Digital input configuration (18-19)	EAL; bAL; PAL; dor; dEF; ES; AUS; Htr; FAn; HdF; onF	dor	Pr1
did	Digital input alarm delay (18-20)	0 to 255 min	15	Pr1

Label	Name	Range	Value	Level
nPS	Number of activation of pressure switch	0 to 15	15	Pr2
odC	Compress and fan status when open door	no; FAn; CPr; F-C	F-C	Pr2
rrd	Regulation restart with door open alarm	n; Y	Y	Pr2
HES	Differential for Energy Saving	[-30 to 30°C] [-54 to 54°F]	0	Pr2
Adr	Serial address	0 to 247	1	Pr2
PbC	Kind of probe	PTC; nTC	nTC	Pr2
onF	on/off key enabling	nu; oFF; ES	nu	Pr2
dP1	Room probe display	probe value	-	Pr1
dP2	Evaporator probe display	probe value	-	Pr1
dP3	Third probe display	probe value	-	Pr1
dP4	Fourth probe display	probe value	-	Pr1
rSE	Real set	actual set	-	Pr2
rEL	Software release	read only	-	Pr2
Ptb	Map code	read only	-	Pr2



Dixell S.r.l. - Z.I. Via dell'Industria, 27 - 32010 Pieve d'Alpago (BL) ITALY
Tel. +39.0437.9833 r.a. - Fax +39.0437.989313 - EmersonClimate.com/Dixell - dixell@emerson.com

dixell		WSL SKY-HORIZON-COMET PLUG IN DOORS ON XR70CH SET PARAMETERS							
Group	Parameter	Description	Edit	Original	Vis. Level	Minimum	Maximum	Unit	Active
Regulation	Hy	Differential	4.0	4.0	Pr1	0.1	25.5	°C	True
	LS	Minimum set point	-5.0	-5.0	Pr2	-55.0	1.0	°C	True
	US	Maximum set point	10.0	10.0	Pr2	1.0	150.0	°C	True
Probes	ot	Thermostat probe calibration	0.0	0.0	Pr1	-12.0	12.0	°C	True
	P2P	Evaporator probe presence	no	no	Pr1				True
	oE	Evaporator probe calibration	0.0	0.0	Pr2	-12.0	12.0	°C	True
	P3P	Third probe presence	Yes	Yes	Pr2				True
	o3	Third probe calibration	0.0	0.0	Pr2	-12.0	12.0	°C	True
	P4P	Fourth probe presence	no	no	Pr2				True
	o4	Fourth probe calibration	0.0	0.0	Pr2	-12.0	12.0	°C	True
Regulation	Ods	Outputs delay at start up	0	0	Pr2	0	255	min	True
	Ac	Anti-short cycle delay	0	0	Pr1	0	50	min	True
	rtr	P1-P2 percentage for regulation	100	100	Pr2	0	100		True
	CCt	Continuous cycle duration	00:00	00:00	Pr2			hour	True
	CCS	Set point for continuous cycle	-5.0	-5.0	Pr2	-55.0	150.0	°C	True
	Con	Compressor ON time with faulty probe	15	15	Pr2	0	255	min	True
	CoF	Compressor OFF time with faulty probe	7	7	Pr2	0	255	min	True
	CF	Temperature measurement unit	°C	°C	Pr2				True
	rES	Resolution	dE	dE	Pr1				True
	Lod	Probe displayed	P1	P1	Pr2				True
	dLy	Display temperature delay	00:00	00:00	Pr2			min	True
	dtr	P1-P2 percentage for display	99	99	Pr2	1	99		True
	Defrost	EdF	Defrost mode	in	in	Pr2			
tdF		Defrost type	EL	EL	Pr1				True
dFP		Probe selection for first defrost	nP	nP	Pr2				True
dtE		Defrost termination temperature first defrost	12.0	12.0	Pr1	-55.0	50.0	°C	True
ldF		Interval between defrost cycles	6	6	Pr1	0	120	hour	True
MdF		(Maximum) length for first defrost	35	35	Pr1	0	255	min	True
dSd		Start defrost delay	0	0	Pr2	0	255	min	True
dFd		Displaying during defrost	it	it	Pr2				True
dAd		Max display delay after defrost	20	20	Pr2	0	255	min	True
Fdt		Draining time	2	2	Pr2	0	255	min	True
dPo		First defrost after start-up	no	no	Pr2				True
dAF		not used	00:00	00:00	Pr2			hour	True
Fan		Fnc	Fan operating mode	O-y	O-y	Pr1			
	Fnd	Fan delay after defrost	0	0	Pr1	0	255	min	True
	FCt	Differential of temperature for forced activation of fans	0	0	Pr2	0	50	°C	True
	FSt	Fan stop temperature	50.0	50.0	Pr1	-55.0	50.0	°C	True
	Fon	Fan on time with compressor off	0	0	Pr2	0	15	min	True
	FoF	Fan off time with compressor off	0	0	Pr2	0	15	min	True
	FAP	Probe selection for fan	nP	nP	Pr2				True
Alarm	ALC	Temperature alarms configuration	Ab	Ab	Pr2				True
	ALU	Maximum temperature alarm	15.0	15.0	Pr1	-50.0	150.0	°C	True
	ALL	Minimum temperature alarm	-50.0	-50.0	Pr1	-55.0	15.0	°C	True
	AFH	Differential for temperature alarm recovery	1.0	1.0	Pr2	0.1	25.5	°C	True
	ALd	Temperature alarm delay	45	45	Pr2	0	255	min	True
	dAo	Delay of temperature alarm at start up	05:00	05:00	Pr2			hour	True
	AP2	Probe selection for condenser temperature alarms	P3	P3	Pr2				True
	AL2	Condenser low temperature alarm	-40.0	-40.0	Pr2	-55.0	150.0	°C	True
	AU2	Condenser high temperature alarm	54.0	54.0	Pr2	-55.0	150.0	°C	True
	AH2	Differ. for condenser temp. alarm recovery	8.0	8.0	Pr2	0.1	25.5	°C	True
	Ad2	Condenser temperature alarm delay	0	0	Pr2	0	255	min	True
	dA2	Delay of condenser temper. alarm at start up	00:00	00:00	Pr2			hour	True
	bLL	Compressor off for condenser low temperature alarm	no	no	Pr2				True
	AC2	Compressor off for condenser high temperature alarm	Yes	Yes	Pr2				True
	tbA	Alarm relay switched off by pushing a key	Yes	Yes	Pr2				True
Configuration	oA3	Third relay configuration	ALr	ALr	Pr2				True
Alarm	AOP	Alarm relay polarity	cL	cL	Pr2				True
Digital inputs	i1P	Digital input 1 polarity	cL	cL	Pr1				True
	i1F	Digital input 1 configuration	dor	dor	Pr1				True
	did	Digital input 1 alarm delay	15	15	Pr1	0	255	min	True
	nPS	Number of activation of pressure switch	15	15	Pr2	0	15		True
Alarm	Odc	Compress and fan status when open door	no	no	Pr2				True
Alarm	rrd	Regulation restart with door open alarm	Yes	Yes	Pr2				True

Energy Saving	HES	Differential for Energy Saving	0	0	Pr2	-30	30	°C	True
Other	Hur	Hour			Pr1				True
Other	Min	Minutes			Pr1				True
Other	dAY	Day of the week			Pr1				True
Regulation	Hd1	First day of week end	nu	nu	Pr1				True
Regulation	Hd2	Second day of week end	nu	nu	Pr1				True
Energy Saving	iLE	Working days Energy saving start time	00:00	00:00	Pr1				True
	dLE	Working days Energy saving duration	00:00	00:00	Pr1				True
	iSE	Holyday Energy saving start time	00:00	00:00	Pr1				True
	dSE	Holyday Energy saving duration	00:00	00:00	Pr1				True
Defrost	Ld1	1st working days defrost start time	06:00	06:00	Pr1				True
	Ld2	2nd working days defrost start time	13:00	13:00	Pr1				True
	Ld3	3rd working days defrost start time	21:00	21:00	Pr1				True
	Ld4	4th working days defrost start time	nu	nu	Pr1				True
	Ld5	5th working days defrost start time	nu	nu	Pr1				True
	Ld6	6th working days defrost start time	nu	nu	Pr1				True
	Sd1	1st Holyday defrost start time	06:00	06:00	Pr1				True
	Sd2	2nd Holyday defrost start time	13:00	13:00	Pr1				True
	Sd3	3rd Holyday defrost start time	21:00	21:00	Pr1				True
	Sd4	4th Holyday defrost start time	nu	nu	Pr1				True
	Sd5	5th Holyday defrost start time	nu	nu	Pr1				True
	Sd6	6th Holyday defrost start time	nu	nu	Pr1				True
Other	Adr	Serial address	1	1	Pr2	1	247		True
Probes	pbC	Kind of probe	ntC	ntC	Pr1				True
Configuration	onF	On/off key configuration	no	no	Pr2				True
Other	dP1	Probe 1 value	0	0	Pr1				True
	dP2	Probe 2 value	0	0	Pr1				True
	dP3	Probe 3 value	0	0	Pr1				True
	dP4	Probe 4 value	0	0	Pr1				True
	rSE	Real Set point (SET + ES + SETd)	0	0	Pr2				True
	rEL	Firmware Release	0	0	Pr2				True
	Ptb	Map code	10	10	Pr2	0	65535		True
Regulation	SEt	Set point	1.0	1.0		-5.0	10.0	°C	True

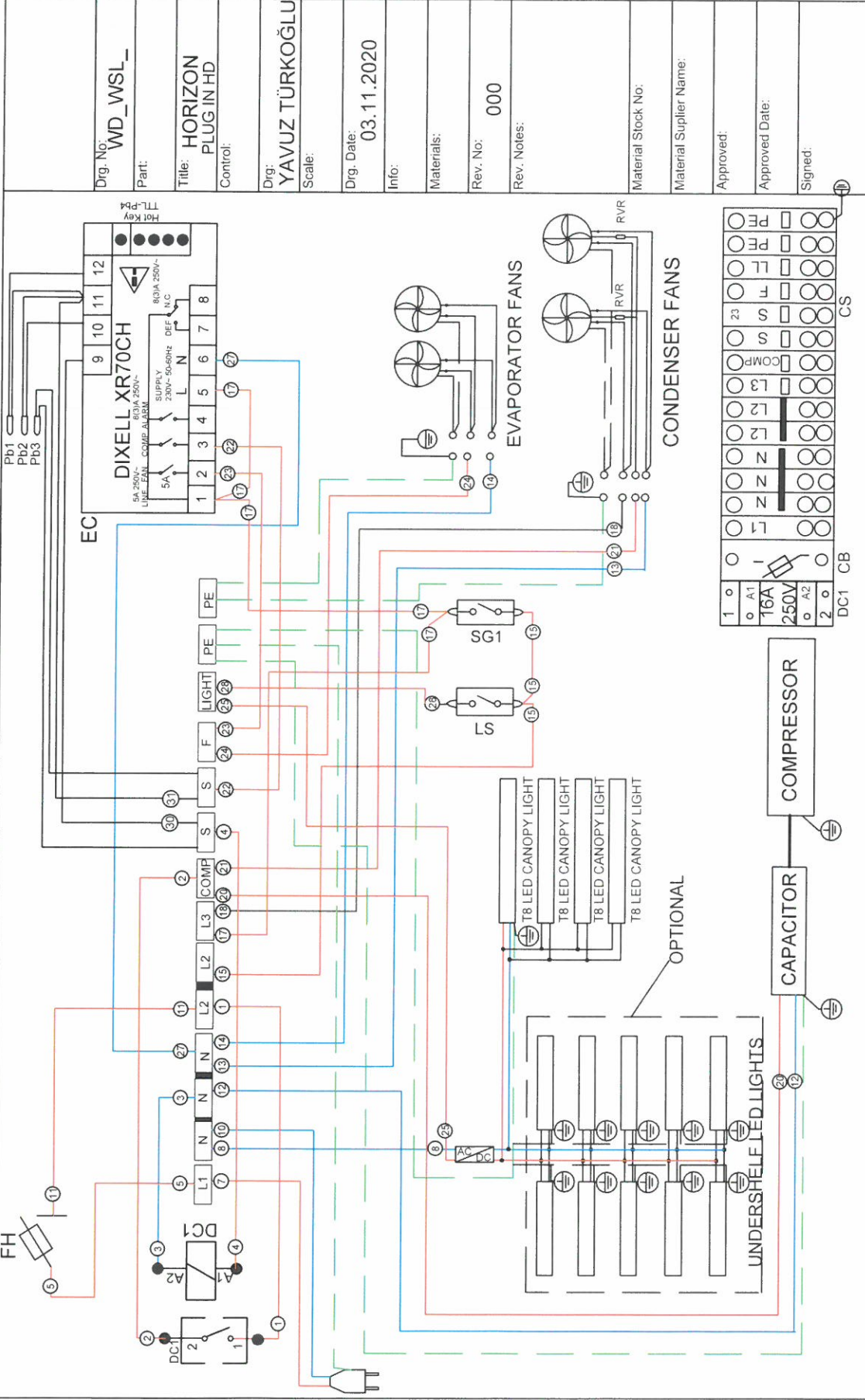

Drg. No: **WD_WSL_**
 Part:
 Title: **HORIZON PLUG IN HD**
 Control:
 Drg: **YAVUZ TÜRKÖĞLÜ**
 Scale:
 Drg. Date: **03.11.2020**
 Info:
 Materials:
 Rev. No: **000**
 Rev. Notes:
 Material Stock No:
 Material Supplier Name:
 Approved:
 Approved Date:
 Signed:

CODE	DESCRIPTION	CODE	DESCRIPTION	CODE	DESCRIPTION
EC	ELECTRONIC CONTROLLER	N	SUPPLY NEUTRAL	PE	EARTH
TB	TERMINAL BOX	L1	SUPPLY PHASE	Pb1	TEMPERATURE PROBE
LS	LIGHT SWITCH	F	FANS	Pb2	DEFROST PROBE
SG1	ON-OFF SWITCH	S	HIGH PRESSURE SWITCH	Pb3	SUCTION PROBE
FH	FUSE HOLDER	S	LOW PRESSURE SWITCH		
DC1	CONTACTOR				